

The Wenlux® Model 717 Beam Mount Accent Light provides the designer with a surface mounted luminaire for highlighting fine art and furniture that can be installed and adjusted with ease. Final adjustment light control is far beyond what the MR16 light source can achieve on its own.

Wenlux 717 accepts a wide range of energy efficient MR16 IR lamps with beam spreads that are further altered by a series of light control accessories. Lenses are positioned within a rotational lens holder cone with virtually no limit to the quantity of accessory lenses. Our unique Fade In® 0° Softening Lens is optional and a Narrow Beam Holder Cone is available to choke stray light for an incredibly tight illumination.

Wenlux includes a sturdy fastening design and convection cooling system that allows for air intake and escape, cooling the lamp and lamp holder chamber for optimal performance. The back box can be fastened to the side of an exposed beam, or directly to a wood or concrete ceiling and includes an internal transformer. For a back box without a transformer, specify remote transformers "RT." Both back boxes accept single dead end Class 1 wiring.

Wendelighting reserves the right to make changes without notice.



DISCONTINUED

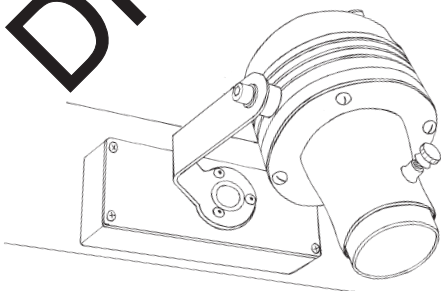

Model 717B

STANDARD SPECIFICATIONS

- Applications:** Accent Illumination
- Power:** 120 VAC
- Transformer:** Electronic Low Voltage 120 VAC Input - 11.5 VAC Output
- Lens:** 14° Softening Lens
- Housing:** Aluminum and Stainless
- Specify Color:** Natural Aluminum (AL) AL/Black, AL/White (White will discolor)
- Mounting:** Beam, Ceiling, or Wall Mount
- Relamping:** Does Not Change Focus
- Weight:** 2.5 lbs.
- Dimmer:** Electronic Low Voltage Dimmer Required (MLV Dimmer for Remote PS300)
- Listing:** UL / CUL - Damp Location - No Feed Through
- Accessories:**
 - See Light Control Accessories Below
 - Remote Transformer Power Supplies
 - Standard MR16 1.9" Dia. UV or Color Filter by Others

Lamp Options

(As of Aug. 2019)

- Philips® IR - Sylvania® IR - Ushio® IR (50 Watt MR16 IR MAX) *
- Ushio® 1004958 MR16 LED Retrofit

For CA Title 24 JA8-2016-E Residential Lighting Requirement

LIGHT CONTROL ACCESSORIES

Degrees shown are approximate based on a 10° NSP lamp. Results may vary substantially using wider beam spread lamps.

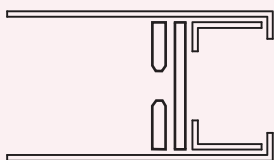

4° Reducing Choke
Narrow Beam Holder Cone

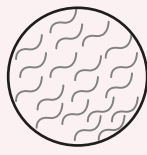

Fade In®
0°
Softening Lens

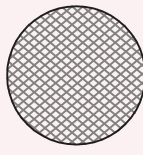

Standard
14°
Softening Lens

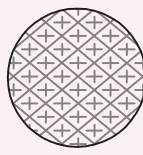

28°
Softening Lens

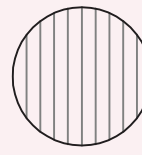

0° x 48°
Rectilinear Lens

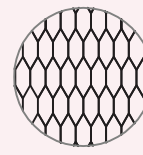

Hexcel Louver
Black

*Not Compliant with CA Title 20
See wendelighting.com/resources

Wenlux® Model 717B

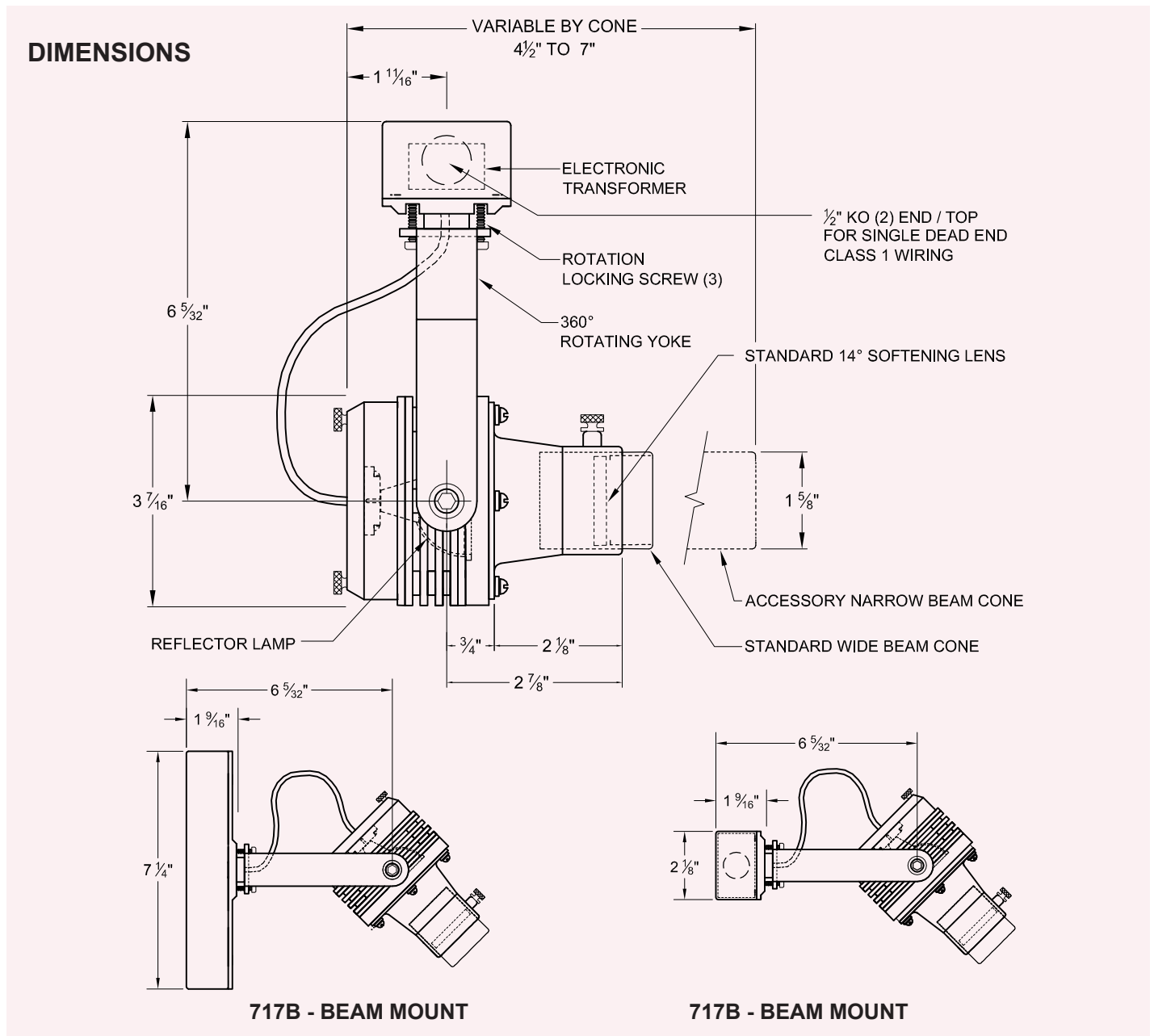

REMOTE TRANSFORMER POWER SUPPLIES

PS60 - 120V Input / 11.7V Output

Electronic Low Voltage Power Supply
For One Beam Mount Luminaire
6 1/2" L x 1 11/16" W x 1 7/16" D
(Note: 6' Max Wire Length)

PS300 - 120V Input / 12V Output

Magnetic Low Voltage Power Supply
For Five Beam Mount Luminaire / Dead End Feeds
6 3/4" L x 5" W x 4 3/4" D

HOW TO SPECIFY

To specify, please visit www.wendelighting.com/worksheets.htm, complete the appropriate projector worksheet and forward the completed worksheet to our staff members, info@wendelighting.com.

The name Wendelighting is registered to Jacksen International Ltd., Monrovia, California. The name encompasses Wendel® and Wenlux® optical projectors as well as other types of Wendel/Wenlux lighting fixtures for both interior and exterior use.



WENDELIGHTING®

DIVISION OF JACKSEN INTERNATIONAL LTD